

INSTRUCTIONS

TAP TEMPERATURE AND PRESSURE GAUGE

English

Installation and operating guide
Temperature And Pressure Gauge

HVAC/R
Service Products



Contents

Introduction	4
General information	6
Important safety notice	7
Technical Data	8
Parts description	9
Transport, packaging and storage	13
Setup, operation	14
Maintenance	19
Guarantee	22
Replacement parts and accessories	22

Introduction

Thank you for your purchase of the REFCO **TAP, Temperature And Pressure** gauge.

The REFCO TAP wireless digital pressure and temperature gauge is a user friendly instrument to measure temperature and pressure from the low and high sides of air conditioning and refrigeration systems.

Features:

- Quick and easy connection to pressure source and temperature measuring point.
- The wireless K-type temperature clamp, equipped with digital display, is applicable for pipe diameters 6 mm to 42 mm (1/4" to 1-5/8").
- Measurements and calculation of superheat or subcooling can be shown on pressure gauge display and / or on your mobile device.
- Up to 6 TAP devices can be monitored on your mobile device.
- Create report and send by e-mail to your office.
- Uses common AAA batteries.
- TAP is available in a suitable case either as single or double set.

CE/FCC Conform

CE/FCC Notice

CE:

This device meets the norm EN300 440.

FCC:

This device meets the requirements in accordance to part 15 of the FCC. Operation occurs under the following terms:

- (1). This device does not produce any harmful interference with reception
- (2). This device must tolerate high-frequency radiation, inclusive radiation which could result in undesired reactions.

Note: The grantee is not responsible for any changes or modifications not expressly approved by the party responsible for compliance. Such modifications could void the user's authority to operate the equipment.

Note: This equipment has been tested and found to comply with the limits for a Class B digital device, pursuant to part 15 of the FCC Rules. These limits are designed to provide reasonable protection against harmful interference in a residential installation. This equipment generates, uses and can radiate radio frequency energy and, if not installed and used in accordance with the instructions, may cause harmful interference to radio communications.

However, there is no guarantee that interference will not occur in a particular installation. If this equipment does cause harmful interference to radio or television reception, which can be determined by turning the equipment off and on, the user is encouraged to try to correct the interference by one or more of the following measures:

- Reorient or relocate the receiving antenna.
- Increase the separation between the equipment and receiver.
- Connect the equipment into an outlet on a circuit different from that to which the receiver is connected.
- Consult the dealer or an experienced radio/TV technician for help.

The device has been evaluated to meet general RF exposure requirement. The device can be used in portable exposure condition without restriction.

General information

The TAP product consists of:

- A wireless temperature clamp with display to monitor sensible temperature.
- A pressure gauge with display to monitor current pressure and temperatures.
- Up to 6 paired devices can be connected to a smartphone or tablet to observe and calculate measurements by using the REFCO App.

TAP

Wireless temperature clamp

Pressure gauge

The TAP referred to in these operating instructions has been manu-



factured using state-of-the-art technology. All components are subjected to rigorous quality assurance criteria during the manufacturing process. Our management systems are certified in accordance with ISO 9001.

The TAP has been developed for long term use. REFCO takes energy saving and environmental impact into consideration when procuring materials and manufacturing its products. REFCO Manufacturing Ltd feels responsible for all of its products throughout their entire lifespan and has therefore been certified in accordance with DIN EN ISO 14001 : 2004. When decommissioning the device, users should observe the disposal regulations applicable in their country.

REFCO products have been specially designed and manufactured for use by trained refrigeration and air-conditioning service engineers only. Due to the high pressures and chemical gases used in refrigeration systems, REFCO cannot be held liable or responsible for any accidents, injuries or deaths arising during use of the TAP. REFCO explicitly states that their products must only be sold to professionally trained service engineers.

These operating instructions contain important information about handling the TAP. Safe operation of the device requires adherence to all safety instructions and operating guidelines.

- The local accident prevention regulations applicable to the area in which the TAP is being used should also be adhered to, along with general safety guidelines.
- The operating instructions are part of the product and must be stored in close proximity to the TAP where they should be readily accessible to qualified personnel at all times.
- The qualified personnel must have carefully read and understood the operating instructions prior to operating the device.
- The manufacturer shall not be liable for any damage whatsoever arising through improper use, failure to comply with these operating instructions, assignment of inadequately qualified personnel, or unauthorised modification of the TAP.
- The General Terms and Conditions as set out in the sales documentation shall apply.

Symbols and writing standards	
Illustration	Explanation
	Warning: Serious physical injury can occur
NOTICE	Damage to the equipment may occur
TAP	Temperature and Pressure measuring device (Temperature clamp + Pressure gauge)
[OK]	Control key of the instrument
"OK"	Expressions and readouts

Important safety notice

Before working with the TAP, please read the instruction manual carefully. This manual provides important information regarding the smooth operation, maintenance and disposal of the TAP.

The TAP must not be used with pressures higher than 60 bar / 870 psi / 6000 kPa.

Protective goggles and gloves should always be worn when using the TAP.

The TAP must not be used with the refrigerant (NH₃ / R-717) ammonia.

The TAP must not be used for anything other than the below-stated purposes.

NOTICE The TAP should not be exposed to moisture or used in damp or wet environments.

NOTICE Remove refrigerants from the TAP and the hoses after use.

Purpose and use

The TAP has been developed for measuring pressure and temperature in both mobile and stationary refrigeration equipment.

TAP is only designed for temporary measurement, don't use it as a stationary long term measurement unit.

Scope of delivery

Information about the various models and variations of our products can be found in the REFCO catalogue or at www.refco.ch. The REFCO App is available on App Store and Play Store.

Technical Data

Temperature clamp, TAP-CLAMP

Property	Value
Thermocouple:	K-type
Temperature range:	-40 °C to +125 °C / -40 °F to +257 °F
Accuracy of measurement:	+/- 1 °C / +/- 1.8 °F
Resolution:	0.1 °C / 0.1 °F
Temperature units:	°C / °F
Pipe diameters of:	6 mm to 42 mm / ¼" to 1-5/8"
Ambient temperature:	0 °C to +50 °C / +32 °F to +122 °F
Storage temperature:	- 20 °C to + 60 °C / -4 °F to 140 °F
Power supply:	3 x 1.5 V AAA / batteries Service life of approx. 50 hours when used continuously. <i>Battery life varies with the brand or age of battery.</i>
Backlight LCD display:	35 mm x 15 mm
Automatic power save mode:	Settable to: 10 min / 20 min / Off
Size:	160 mm x 80 mm x 40 mm
Weight:	180 gr / 6.4 oz

Pressure gauge

Property	Value
Maximum working pressure:	60 bar / 870 psi / 6000 kPa / 6 MPa
Pressure resolution:	0.07 bar / 0.1 psi / 7 kPa / 0.007 MPa
Pressure units:	bar / psi / kPa / MPa
Positive pressure display:	up to 60 bar, up to 870 psi, up to 6000 kPa, up to 6 MPa
Accuracy:	≤ 1.0% FS
Power supply:	4 x 1.5 V AAA / batteries Service life of approx. 40 hours when used continuously. <i>Battery life varies with the brand or age of battery.</i>
Storage temperature:	- 20 °C to + 60 °C / -4 °F to 140 °F
Backlit LCD display:	40 mm x 30 mm
Automatic power save mode:	Settable 10 min / 20 min / Off
Interface:	Micro USB
Connection fitting:	¼" SAE
Size:	125 mm x 57 mm x 34 mm
Weight:	200 gr / 7.0 oz

The TAP can be used with the following refrigerants:

R11, R113, R114, R12, R123, R124, R13, R134a, R13B1, R22, R227, R23, R290, R32 R401A(Liq), R401A(Vap), R401B(Liq), R401B(Vap), R402A(Liq), R402A(Vap), R402B(Liq), R402B(Vap), R403B(Liq), R403B(Vap), R404A, R406A (Liq), R406A(Vap), R407A(Liq), R407A(Vap), R407B, R407C(Liq), R407C(Vap), R407F(Liq), R407F (Vap), R408A(Liq), R408A(Vap), R409A(Liq), R409A(Vap), R410A, R413A(Liq), R413A(Vap), R414B(Liq), R414B(Vap), R416A(Liq), R416A(Vap), R417A(Liq), R417A(Vap), R420A, R422A(Liq), R422A (Vap), R422B(Liq), R422B(Vap), R422C(Liq), R422C(Vap), R422D(Liq), R422D(Vap), R427A(Liq), R427A(Vap), R437A, R438A(Liq), R438A (Vap), R448A(Liq), R448A(Vap), R449A(Liq), R449A(Vap), R450A(Liq), R450A(Vap), R452A(Liq), R452A(Vap), R500, R502, R503, R507, R508A, R508B, R513A, R600a, R744, R1233zd, R1234yf, R1234ze

(Liq) = liquid / bubble point, (Vap) = vapour / dew point

Parts description



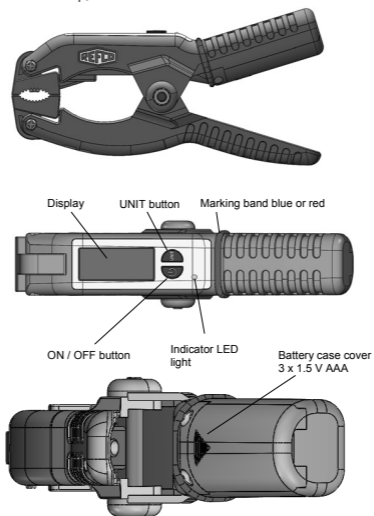

Temperature Clamp, TAP-CLAMP

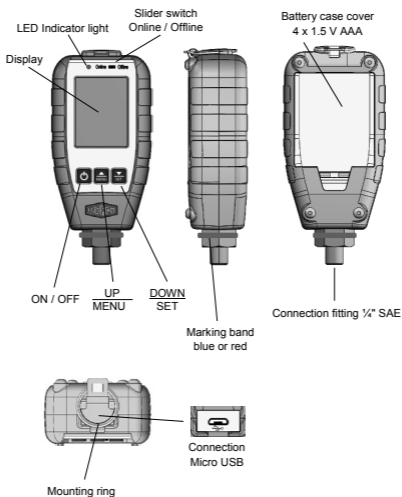

Pressure Gauge



Buttons and functions of TAP CLAMP

	ON / OFF 	UNIT 
ON / OFF	ON by short pressing < 1 sec.	OFF by pressing ≥ 1 sec.
	<ul style="list-style-type: none"> - Backlight on - Start image on (Backlight shuts off after 1 min.) 	<ul style="list-style-type: none"> - Display shows "OFF" - Backlight off - Display off
	Backlight ON/OFF Only in system On-mode by pressing	
	Auto Off	
	- Factory default auto off time = 20 min (configurable)	
UNIT	UNIT by short pressing < 1 sec.	UNIT by pressing ≥ 1 sec.
	<ul style="list-style-type: none"> - °C appears - °F appears (Once set, setting remains) 	<ul style="list-style-type: none"> - No function - To escape from last set menu

ON / OFF
+
UNIT

By pressing [ON/OFF] + [UNIT] button same time < 1 sec. the following mode is activated:

- Set number of TAP-CLAMP. Scroll from T1 to T6 by pressing [UNIT] button < 1 sec. (once set, setting remains)

By pressing [ON/OFF] + [UNIT] button same time > 1 sec. the following mode is activated:

- Set Auto Off as required. 10 min / 20 min / OFF. (Factory default value is 20 min.)

Scroll from 10 / 20 / OFF by pressing [UNIT] button < 1 sec. (once set, the setting remains)

Indicator LED light

Green LED light flashing	No LED light
- Power on - Wireless transmission to pressure gauge on.	- Power off - Wireless transmission to pressure gauge off.

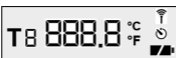
Display

T1...T6	Number of TAP CLAMP T1 to T6
°C °F	Temperature units
	Transmitting symbol Flashing during connection setup. Constant after connection.
	Auto Off 10 min. / 20 min. / OFF
	Low battery indication If the battery charge level < 30%, the battery empty symbol will appear on display. The batteries must then be replaced within two hours in order to guarantee full function.

Buttons and functions on TAP Pressure Gauge



ON / OFF

Scroll UP
MENUScroll DOWN
SET

ON / OFF

**ON** by short pressing < 1 sec. **OFF** by pressing \geq 1 sec.

- Backlight on
- Start image on
(Backlight shuts off after 1 min.)

- Display shows "OFF"
- Backlight off
- Display off

Backlight ON/OFF

Only in system On-modus by short pressing [ON] < 1 sec. (Backlight shuts off after 1 min.)

Auto Off

- Factory default auto off time = 20 min.

UP /
MENU**UP** by short pressing < 1 sec. **MENU** by pressing \geq 1 sec.

- To scroll up

- To enter menu mode
- To escape from last set menu

DOWN /
SET**DOWN** by short pressing < 1 sec. **SET** by pressing \geq 1 sec.

- To scroll up

- To confirm selection

Indicator
LED light
green

Online











Offline

Slider
switch

Online	Offline
<ul style="list-style-type: none"> - Wireless transmission to smart device on 	<ul style="list-style-type: none"> - Wireless transmission to smart device off
<ul style="list-style-type: none"> - Measurements transmitting continuous to smart device. - LED light on. - Wireless connection to smart device is active. - To use TAP with smart device. 	<ul style="list-style-type: none"> - No measurements transmitting to smart device. - LED light off. - No wireless connection to smart device. - To use TAP without smart device. - To safe battery life.
<p>Note: Wireless transmission between temperature clamp and pressure gauge remains always on. Pressure gauge always receives signal from temperature clamp if within 10 m / 33 ft of each other.</p>	

Display

	TAP1		
	R000		
P1	0.00	bar	
To/c	0.0	°C	
T1	0.0	°C	
ΔT	0.0	K	

TAP1...TAP6	ID of TAP pressure gauge T1 to T6	
R000	Refrigerants menu Menu with stored refrigerant charts	
P1...P6	bar, psi kPa, MPa	Pressure units (P) = Pressure
To/c	°C °F	Temperature units (To = Evaporating temperature) (Tc = Condensing temperature)
T1..T6	°C °F	Temperature units (T) = Temperature from TAP-CLAMP
ΔT	K °F	Temperature difference (ΔT) = Temperature difference
	Settings	
	Transmitting symbol Flashing during connection setup. Constant after connection.	
 TAP1  	Low battery indication of TAP pressure gauge If the battery charge level < 30%, the battery empty symbol will appear on display. The batteries must then be replaced within two hours in order to guarantee full function.	
T1  0.0 °C	Low battery indication of connected TAP CLAMP	

Transport, packaging and storage**Transport**

The TAP is delivered from the factory in a plastic box, with or without different accessories as ordered. Inspect the TAP for any potential transportation damage. Any obvious damage should be reported to the vendor immediately. TAP is a high-grade instrument and should be transported and stored in a box, for long term protection.

Packaging

Retain the original packaging as it provides optimum protection for transportation of the device (e.g. onward dispatch of the device, sending it for repair etc.).

Storage

- Storage temperature: -20 °C to +60 °C
- Humidity: 0 to 90% relative humidity (no condensation)

Setup and operation**TAP CLAMP**

Set-up TAP CLAMP Insert 3 x 1.5 V (AAA) batteries in the battery compartment of the TAP CLAMP.

NOTICE

Ensure the batteries are inserted observing the correct polarities. Do not leave dead batteries in the battery compartment. If you will not be using the TAP CLAMP for a long period of time, remove the batteries from the battery compartment.

Switch on - Press [ON/OFF] button, to switch on device.
After start image, display appears

Set TAP CLAMP ID

- Press [ON/OFF] + [UNIT] button same time < 1 sec. to enter set mode.
- Scroll from T1 to T6 by pressing [UNIT] button < 1 sec.
- Press [ON/OFF] button ≥ 1 sec. to confirm and return to main display.

Note:

Chosen ID will be transmitting to pressure gauge and is shown on display.

Set Auto Off

- Press [ON/OFF] + [UNIT] button same time > 1 sec. to enter set mode.
- When Auto Off mode is activated timer symbol  appears.
- Scroll from 10 / 20 / OFF by pressing [UNIT] button < 1 sec.
- Press [ON/OFF] button ≥ 1 sec. to confirm and return to main menu.

Note:

*Factory default Auto Off is set to 20 min.
Subsequent the symbol and the auto off time disappear from display.*

Set unit

- Press [UNIT] button < 1sec.
- Switch between °C and °F by using [UNIT] button < 1 sec.

TAP Pressure Gauge

Set-up TAP Insert 4 x 1.5 V (AAA) batteries in the battery compartment on the back side of the TAP.

NOTICE

Ensure the batteries are inserted observing the correct polarities. Do not leave dead batteries in the battery compartment. If you will not be using the TAP pressure gauge for a long period of time, remove the batteries from the battery compartment.

- Switch on** - Press [ON] button to switch on device.
After start, REFCO-logo appears on display.
- Set TAP ID** - Press [MENU] button ≥ 1 sec. to activate selection mode.
TAP ID menu is selected.
- Press [SET] button ≥ 1 sec. to enter TAP ID menu.
 - Choose a TAP ID number by pressing [UP] or [DOWN] button < 1 sec.
 - Press [SET] button ≥ 1 sec. to confirm selected ID.
 - Press [MENU] button ≥ 1 sec. to return to main display.

Note:

Number for P1 to P6 is always concurrent with the TAP number.

Set refrigerant To change current refrigerant setting:

- Press [MENU] button ≥ 1 sec. to activate selection mode.
- Press [DOWN] button < 1 sec. to scroll down to the refrigerant menu.
- Press [SET] button ≥ 1 sec. to enter refrigerant menu.
- Press [UP] or [DOWN] button ≥ 1 sec. to scroll to the desired field refrigerant type entry.
- Press [SET] button ≥ 1 sec. to confirm.
- Press [MENU] button ≥ 1 sec. to return to main display.

Note:

*The first 6 refrigerants can be favorites.
Following are all known refrigerants from library.*

Note on R000:

Additional function to select from table of refrigerant: If use entry "R000" it means "Pressure only". No readouts from chart. It gives the possibility to measure only pressure and temperature without any refrigerant chart temperatures shown.

Set favorites

- Press [MENU] button ≥ 1 sec. to activate selection mode.
- Press [DOWN] button < 1 sec. to scroll down to the refrigerant menu.
- Press [SET] button ≥ 1 sec. to enter refrigerant menu.
- Press [UP] or [DOWN] button < 1 sec. to scroll to the desired refrigerant.
- Press [ON/OFF] button < 1 sec. to add refrigerant to favorites.

Note:

New favorite is placed at first of column.

Last of the 6 entries drops out.

Set pressure unit

- Press [MENU] button ≥ 1 sec. to activate selection mode.
- Press [DOWN] button < 1 sec. to scroll down to the pressure unit menu.
- Press [SET] button ≥ 1 sec. unit field will flash.
- Press [UP] or [DOWN] button < 1 sec. to select pressure unit.
- Press [SET] button ≥ 1 sec. to confirm.
- Press [MENU] button ≥ 1 sec. to return to main display.

Set temperature unit

- Press [MENU] button ≥ 1 sec. to activate selection mode.
- Press [DOWN] button < 1 sec. to scroll down to the temperature unit menu.
- Press [SET] button ≥ 1 sec. unit field will flash.
- Press [UP] or [DOWN] button < 1 sec. to select temperature unit.
- Press [SET] button ≥ 1 sec. to confirm.
- Press [MENU] button ≥ 1 sec. to return to main display.

- Pairing**
- Ensure the distance between the devices is less than 5 meters.
 - Ensure TAP CLAMP(S) which shall be paired with TAP pressure gauge are switched on.
 - Ensure TAP pressures gauge is on.
 - Set sliding switch on device to "online".
 - Press [MENU] button ≥ 1 sec. on TAP pressure gauge to activate selection mode.
 - Press [DOWN] button < 1 sec. of TAP pressure gauge to scroll down to the field "T".
 - Press [SET] button ≥ 1 sec. to start scanning. Display of TAP pressure gauge shows "Scan..."

Note:

If no device can be found, "No Signal" appears on display before return to menu.

- If device be found, display shows a list of found TAP CLAMP ID(s).
- Select desired TAP CLAMP ID by pressing [UP] or [DOWN] button < 1 sec.
- Press [SET] button ≥ 1 sec. to start pairing. During pairing procedure, display shows "Connect...". If pairing was successful, display shows "END". Paired TAP CLAMP is recognised on TAP display with T and relevant number (1 to 6).
- If pairing was not successful, display shows "ERROR". If this happens, repeat steps above and try again.

Change Settings

- Press [MENU] button ≥ 1 sec. to activate selection mode.
- Press [UP] button < 1 sec. to scroll up to the setting field .
- Press [SET] button ≥ 1 sec. to enter settings menu.
- Press [UP] or [DOWN] button < 1 sec. to scroll to the desired field.

Available fields:

Auto Off
Update
Version
SD Mode
P-Zero

- Press [SET] button ≥ 1 sec. to confirm.

Auto Off

- Press [UP] or [DOWN] button < 1 sec. to choose the auto shutoff option. (10 min. / 20 min. / Off)
- Press [SET] button ≥ 1 sec. to confirm.

Update	Updating refrigerants. See in chapter maintenance.
Version	Current version of refrigerant chart is shown.
SD Mode	This function is used in combination for update. See in chapter maintenance.
P-Zero	Resetting pressure sensor. See in chapter maintenance / Resetting pressure sensor

Maintenance

- A visual inspection of the connections and hoses must be carried out before each use to check for mechanical damage.
- Do not use aggressive cleaning agents or solvents to clean the device. Gentle household cleaners and soapy water should be used instead.
- TAP seals are subject to mechanical and age-related wear. Therefore, the TAP should be regularly tested by the user for leaks.

Resetting pressure sensor on TAP pressure gauge

The TAP pressure sensor can be reset in order to avoid incorrect measurement values.

P-Zero

NOTICE To obtain a correct measurement value on the display, the TAP should not be reset when pressurised.

1. Ensure TAP pressure gauge is switched on.
2. Press [MENU] button ≥ 1 sec. to activate selection mode.
3. Press [UP] button < 1 sec. to scroll up to the setting field .
4. Press [SET] button ≥ 1 sec. to enter settings menu.
5. Press [UP] or [DOWN] button < 1 sec. to scroll to the "P-Zero" field.
6. Enter "P-Zero" by pressing [SET] button ≥ 1 sec.
7. Display shows 0.0psi
8. Press [SET] button ≥ 1 sec. for confirmation.
9. Display shows setting menu.
10. Press [MENU] button ≥ 1 sec. to quit.

Updating of refrigerants on TAP pressure gauge via Micro USB

The TAP pressure gauge supports updates of refrigerant data via Micro USB. The latest refrigerant charts can be found at www.refco.ch

Updating refrigerants

1. Ensure TAP pressure gauge is switched on.
2. Press [MENU] button ≥ 1 sec. to activate selection mode.
3. Press [UP] button < 1 sec. to scroll up to the setting field .
4. Press [SET] button ≥ 1 sec. to enter settings menu.
5. Press [UP] or [DOWN] button < 1 sec. to scroll to the "SD Mode" field.
6. Enter "SD Mode", select "USB MSC".
7. Connect TAP to computer by USB connection; the device shown on computer.
8. Copy the file "Refriger .bin" to the folder "Refriger" which is under the device.
9. Disconnect the TAP from computer.
10. Enter "SD Mode", select "SD FAFS"
11. Enter "Update" (MENU) to update the refrigerant data.

Calibration

The accuracy of all measuring devices will degrade over time. Calibration improves the accuracy of the TAP. On this device temperature and pressure can be re-calibrated. Temperature calibration can be done using two procedures: calibration using ice water as reference or by using room temperature as reference.

Calibration of TAP-CLAMP

NOTICE Risk of short circuit. If the electronic components come into contact with water, short circuits are possible. Don't dunk the TAP-CLAMP below max. water level. (See figure below)

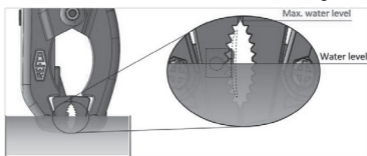

Ice water calibration (0 °C / 32 °F)

NOTICE Risk of short circuit. If the electronic components come into contact with water, short circuits are possible. Dunk the TAP-CLAMP below max. water level as shown.

1. Prepare ice water:

Take your time, use lots of ice and stir water often. It can take up to 15 minutes for the ice water temperature to settle exactly at 0.0 °C / 32.0 °F Use separate accurate thermometer to verify water temp.

For best results use an insulated cup, do not let the sensor tips touch any ice cubes, only the ice water in the top 2-3 cm of the ice bath after +/- 15 min. Do not touch or hold the sensor wires.

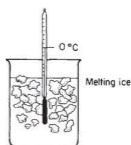

2. Turn off the TAP-CLAMP.
3. While holding [UNIT], press [ON / OFF] until display shows "CALL"
4. Release both buttons, the display shows "00"
5. Press [UNIT] button < 1 sec. to adjust the number to "06"
6. Press [ON / OFF] button < 1 sec., the display shows "00 °C"
7. Press [UNIT] button < 1 sec. to show a code of temperature
8. Put the K - thermocouple (plate) into 0 °C ice water.
9. Wait the temperature code reading to be steady, press [UNIT] button < 1 sec.
10. The display shows the ambient temperature.
11. Press [UNIT] button < 1 sec. to quit the temperature calibration.

Room temperature calibration

1. Turn off the TAP-CLAMP.
2. Place the TAP-CLAMP at constant temperature at 25 ± 3 °C condition for 2 hrs. to ensure the temperature of the K - thermocouple to be even.
3. While holding [UNIT], press [ON / OFF] until display shows "CALL"
4. Release both buttons, the display shows "00"
5. Press [UNIT] button < 1 sec. to adjust the number to "09"
6. Press [ON / OFF] button < 1 sec. to show a code of temperature.
7. Wait the temperature code reading to be steady, press [ON / OFF] button < 1 sec.
8. The display shows the ambient temperature.
9. Press [ON / OFF] button < 1 sec. to quit the temperature calibration.

Calibration of pressure gauge

Pressure calibration

1. Turn off the TAP.
 2. While holding [UP / MENU] button, press [ON / OFF] button, the display shows "P-CALL"
 3. Press [DOWN / SET] button until the display shows "Password 00"
 4. Press [UP / MENU] button shortly to adjust the number to "Password 8"
 5. Press [DOWN / SET] button until the display shows a reading which is presenting the unload pressure. (i.e. 0.0 psi)
 6. Press [DOWN / SET] awhile to enter calibration
- NOTICE** Ensure all the refrigerant is exhausted from TAP valve or connected hoses before performing calibration. The accuracy will be affected due to the remaining refrigerant.
7. While entering calibration, the display shows "400.0 psi". The default pressure of calibration standard is 400 psi.
 8. Press [UP / MENU] button shortly to select the calibration standard. The inlet pressure must be equal to the calibration standard pressure.
 9. Press [DOWN / SET] awhile for calibration standard confirmation; the display shows the reading of unloaded pressure.
 10. Wait until the reading of unload pressure is stable, pressurize 400 psi (the inlet pressure must be equal to the calibration standard pressure). The display shows the corresponding pressure value (i.e. 400.0 psi)
 11. When the reading is stable, press [DOWN / SET] for confirmation. Now the display shows "END"
 12. Press [DOWN / SET] awhile to quit the pressure calibration.

Guarantee

Your new TAP has been developed in accordance with the latest occupational health and ergonomic requirements and reflects the latest state-of-the-art technology. REFCO Manufacturing Ltd has been certified in accordance with DIN EN ISO 9001: 2008. Regular quality control checks as well as an accurate manufacturing process guarantee reliable functionality and are the basis for the REFCO guarantee, in accordance with the General Terms and Conditions of Sale and Delivery applicable on the day of delivery. Damages arising from obvious maltreatment or wear are excluded from the guarantee.

Return and disposal

Dispose of faulty rechargeable batteries/spent batteries in accordance with the valid legal specifications. At the end of its useful life, send the product to the separate collection for electric and electronic devices (observe local regulations).

Replacement parts and accessories

Description	Identifier	P/N
TAP pressure gauge	TAP	4687787
TAP clamp	TAP-CLAMP	4687785
¼" SAE hose red	CL-6-R	9881265
¼" SAE hose blue	CL-6-B	9881256
¼" SAE hose yellow	CL-6-Y	9881274
Quick coupler straight ¼" SAE	QC-S4A-1/4"SAE/2	4687823
Quick coupler straight 5/16" SAE	QC-S4A-5/16" SAE/2	4687824
Swivel Arm ¼" SAE-N	SWIVEL-ARM-1/4"SAE-N	4687631
Threaded T-style SAE ¼" female with swivel nut	A-31851/1	4687854
Adapter ¼" SAE x 5/16" SAE	QC-S410A/2	4687095
Marking rings for TAP 4x2 pcs/size	TAP-MARKING-RING- SET	4687793
Case to TAP-Set	TAP-CASE-01	4687679
Case to TAP-Double-SET	TAP-CASE-02	4687775

INSTRUCTIONS

HVAC/R
Service Products



REFCO Manufacturing Ltd.

Industriestrasse 11
6285 Hitzkirch - Switzerland

Telefon +41 41 919 72 82

Telefax +41 41 919 72 83

info@refco.ch

www.refco.ch

4017/4687790